

# NTLJD3119C

## Power MOSFET

20 V/-20 V, 4.6 A/-4.1 A,  $\mu$ Cool™

Complementary, 2x2 mm, WDFN Package

### Features

- Complementary N-Channel and P-Channel MOSFET
- WDFN Package with Exposed Drain Pad for Excellent Thermal Conduction
- Footprint Same as SC-88 Package
- Leading Edge Trench Technology for Low On Resistance
- 1.8 V Gate Threshold Voltage
- Low Profile (< 0.8 mm) for Easy Fit in Thin Environments
- This is a Pb-Free Device

### Applications

- Synchronous DC-DC Conversion Circuits
- Load/Power Management of Portable Devices like PDA's, Cellular Phones and Hard Drives
- Color Display and Camera Flash Regulators

### MAXIMUM RATINGS (T<sub>J</sub> = 25°C unless otherwise noted)

Parameter		Symbol	Value	Unit
Drain-to-Source Voltage	N-Ch	V <sub>DSS</sub>	20	V
	P-Ch		-20	
Gate-to-Source Voltage	N-Ch	V <sub>GS</sub>	±8.0	V
	P-Ch			
N-Channel Continuous Drain Current (Note 1)	Steady State	T <sub>A</sub> = 25°C	I <sub>D</sub>	3.8
		T <sub>A</sub> = 85°C		2.8
		t ≤ 5 s	T <sub>A</sub> = 25°C	
P-Channel Continuous Drain Current (Note 1)	Steady State	T <sub>A</sub> = 25°C	I <sub>D</sub>	-3.3
		T <sub>A</sub> = 85°C		-2.4
		t ≤ 5 s	T <sub>A</sub> = 25°C	
Power Dissipation (Note 1)	Steady State	T <sub>A</sub> = 25°C	P <sub>D</sub>	1.5
				2.3
N-Channel Continuous Drain Current (Note 2)	Steady State	T <sub>A</sub> = 25°C	I <sub>D</sub>	2.6
		T <sub>A</sub> = 85°C		1.9
P-Channel Continuous Drain Current (Note 2)	Steady State	T <sub>A</sub> = 25°C	I <sub>D</sub>	-2.3
		T <sub>A</sub> = 85°C		-1.6
Power Dissipation (Note 2)	Steady State	T <sub>A</sub> = 25°C	P <sub>D</sub>	0.71
Pulsed Drain Current	N-Ch	t <sub>p</sub> = 10 μs	I <sub>DM</sub>	18
	P-Ch			-20
Operating Junction and Storage Temperature		T <sub>J</sub> , T <sub>STG</sub>	-55 to 150	°C
Lead Temperature for Soldering Purposes (1/8" from case for 10 s)		T <sub>L</sub>	260	°C

Stresses exceeding Maximum Ratings may damage the device. Maximum Ratings are stress ratings only. Functional operation above the Recommended Operating Conditions is not implied. Extended exposure to stresses above the Recommended Operating Conditions may affect device reliability.

1. Surface Mounted on FR4 Board using 1 in sq pad size (Cu area = 1.127 in sq [2 oz] including traces).
2. Surface Mounted on FR4 Board using the minimum recommended pad size of 30 mm<sup>2</sup>, 2 oz Cu.



ON Semiconductor®

<http://onsemi.com>

V <sub>(BR)DSS</sub>	R <sub>DS(on)</sub> MAX	I <sub>D</sub> MAX
N-Channel 20 V	65 mΩ @ 4.5 V	3.8 A
	85 mΩ @ 2.5 V	2.0 A
	120 mΩ @ 1.8 V	1.7 A
P-Channel -20 V	100 mΩ @ -4.5 V	-4.1 A
	135 mΩ @ -2.5 V	-2.0 A
	200 mΩ @ -1.8 V	-1.6 A

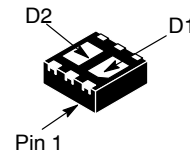

### MARKING DIAGRAM

WDFN6  
CASE 506AN

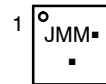

JM = Specific Device Code  
M = Date Code  
▪ = Pb-Free Package  
(Note: Microdot may be in either location)

### PIN CONNECTIONS

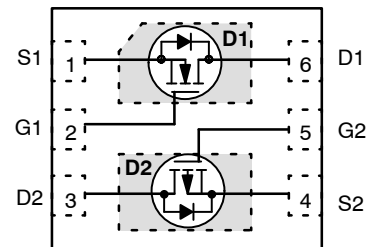

(Top View)

### ORDERING INFORMATION

Device	Package	Shipping†
NTLJD3119CTAG	WDFN6 (Pb-Free)	3000/Tape & Reel
NTLJD3119CTBG	WDFN6 (Pb-Free)	3000/Tape & Reel

†For information on tape and reel specifications, including part orientation and tape sizes, please refer to our Tape and Reel Packaging Specification Brochure, BRD8011/D.

# NTLJD3119C

## THERMAL RESISTANCE RATINGS

Parameter	Symbol	Max	Unit
-----------	--------	-----	------

### SINGLE OPERATION (SELF-HEATED)

Junction-to-Ambient – Steady State (Note 3)	$R_{\theta JA}$	83	°C/W
Junction-to-Ambient – Steady State Min Pad (Note 4)	$R_{\theta JA}$	177	
Junction-to-Ambient – $t \leq 5$ s (Note 3)	$R_{\theta JA}$	54	

### DUAL OPERATION (EQUALLY HEATED)

Junction-to-Ambient – Steady State (Note 3)	$R_{\theta JA}$	58	°C/W
Junction-to-Ambient – Steady State Min Pad (Note 4)	$R_{\theta JA}$	133	
Junction-to-Ambient – $t \leq 5$ s (Note 3)	$R_{\theta JA}$	40	

3. Surface Mounted on FR4 Board using 1 in sq pad size (Cu area = 1.127 in sq [2 oz] including traces).
4. Surface Mounted on FR4 Board using the minimum recommended pad size (30 mm<sup>2</sup>, 2 oz Cu).

# NTLJD3119C

## ELECTRICAL CHARACTERISTICS (T<sub>J</sub> = 25°C unless otherwise noted)

Parameter	Symbol	N/P	Test Conditions	Min	Typ	Max	Unit
<b>OFF CHARACTERISTICS</b>							
Drain-to-Source Breakdown Voltage	V <sub>(BR)DSS</sub>	N	V <sub>GS</sub> = 0 V	I <sub>D</sub> = 250 μA	20		V
		P		I <sub>D</sub> = -250 μA	-20		
Drain-to-Source Breakdown Voltage Temperature Coefficient	V <sub>(BR)DSS</sub> /T <sub>J</sub>	N			10.4		mV/°C
		P			9.95		
Zero Gate Voltage Drain Current	I <sub>DSS</sub>	N	V <sub>GS</sub> = 0 V, V <sub>DS</sub> = 16 V	T <sub>J</sub> = 25 °C		1.0	μA
		P	V <sub>GS</sub> = 0 V, V <sub>DS</sub> = -16 V			-1.0	
		N	V <sub>GS</sub> = 0 V, V <sub>DS</sub> = 16 V	T <sub>J</sub> = 85 °C		10	
		P	V <sub>GS</sub> = 0 V, V <sub>DS</sub> = -16 V			-10	
Gate-to-Source Leakage Current	I <sub>GSS</sub>	N	V <sub>DS</sub> = 0 V, V <sub>GS</sub> = ±8.0 V			±100	nA
		P	V <sub>DS</sub> = 0 V, V <sub>GS</sub> = ±8.0 V			±100	

## ON CHARACTERISTICS (Note 5)

Gate Threshold Voltage	V <sub>GS(TH)</sub>	N	V <sub>GS</sub> = V <sub>DS</sub>	I <sub>D</sub> = 250 μA	0.4	0.7	1.0	V
		P		I <sub>D</sub> = -250 μA	-0.4	-0.7	-1.0	
Gate Threshold Temperature Coefficient	V <sub>GS(TH)</sub> /T <sub>J</sub>	N				-3.0		mV/°C
		P				2.44		
Drain-to-Source On Resistance	R <sub>DS(on)</sub>	N	V <sub>GS</sub> = 4.5 V, I <sub>D</sub> = 3.8 A		37	65	mΩ	
		P	V <sub>GS</sub> = -4.5 V, I <sub>D</sub> = -4.1 A		75	100		
		N	V <sub>GS</sub> = 2.5 V, I <sub>D</sub> = 2.0 A		46	85		
		P	V <sub>GS</sub> = -2.5 V, I <sub>D</sub> = -2.0 A		101	135		
		N	V <sub>GS</sub> = 1.8 V, I <sub>D</sub> = 1.7 A		65	120		
		P	V <sub>GS</sub> = -1.8 V, I <sub>D</sub> = -1.6 A		150	200		
Forward Transconductance	g <sub>FS</sub>	N	V <sub>DS</sub> = 10 V, I <sub>D</sub> = 1.7 A		4.2		S	
		P	V <sub>DS</sub> = -5.0 V, I <sub>D</sub> = -2.0 A		3.1			

## CHARGES, CAPACITANCES AND GATE RESISTANCE

Input Capacitance	C <sub>ISS</sub>	N	f = 1.0 MHz, V <sub>GS</sub> = 0 V	V <sub>DS</sub> = 10 V		271	pF
		P		V <sub>DS</sub> = -10 V		531	
Output Capacitance	C <sub>OSS</sub>	N		V <sub>DS</sub> = 10 V		72	
		P		V <sub>DS</sub> = -10 V		91	
Reverse Transfer Capacitance	C <sub>RSS</sub>	N		V <sub>DS</sub> = 10 V		43	
		P		V <sub>DS</sub> = -10 V		56	
Total Gate Charge	Q <sub>G(TOT)</sub>	N	V <sub>GS</sub> = 4.5 V, V <sub>DS</sub> = 10 V, I <sub>D</sub> = 3.8 A		3.7	nC	
		P	V <sub>GS</sub> = -4.5 V, V <sub>DS</sub> = -10 V, I <sub>D</sub> = -2.0 A		5.5		
Threshold Gate Charge	Q <sub>G(TH)</sub>	N	V <sub>GS</sub> = 4.5 V, V <sub>DS</sub> = 10 V, I <sub>D</sub> = 3.8 A		0.3		
		P	V <sub>GS</sub> = -4.5 V, V <sub>DS</sub> = -10 V, I <sub>D</sub> = -2.0 A		0.7		
Gate-to-Source Charge	Q <sub>GS</sub>	N	V <sub>GS</sub> = 4.5 V, V <sub>DS</sub> = 10 V, I <sub>D</sub> = 3.8 A		0.6		
		P	V <sub>GS</sub> = -4.5 V, V <sub>DS</sub> = -10 V, I <sub>D</sub> = -2.0 A		1.0		
Gate-to-Drain Charge	Q <sub>GD</sub>	N	V <sub>GS</sub> = 4.5 V, V <sub>DS</sub> = 10 V, I <sub>D</sub> = 3.8 A		1.0		
		P	V <sub>GS</sub> = -4.5 V, V <sub>DS</sub> = -10 V, I <sub>D</sub> = -2.0 A		1.4		

# NTLJD3119C

## ELECTRICAL CHARACTERISTICS (T<sub>J</sub> = 25°C unless otherwise noted)

Parameter	Symbol	N/P	Test Conditions	Min	Typ	Max	Unit
<b>SWITCHING CHARACTERISTICS</b> (Note 6)							
Turn-On Delay Time	t <sub>d(ON)</sub>	N	V <sub>GS</sub> = 4.5 V, V <sub>DD</sub> = 16 V, I <sub>D</sub> = 1.0 A, R <sub>G</sub> = 2.0 Ω		3.8		ns
Rise Time	t <sub>r</sub>				4.7		
Turn-Off Delay Time	t <sub>d(OFF)</sub>				11.1		
Fall Time	t <sub>f</sub>				5.8		
Turn-On Delay Time	t <sub>d(ON)</sub>	P	V <sub>GS</sub> = -4.5 V, V <sub>DD</sub> = -10 V, I <sub>D</sub> = -2.0 A, R <sub>G</sub> = 2.0 Ω		5.2		
Rise Time	t <sub>r</sub>				13.2		
Turn-Off Delay Time	t <sub>d(OFF)</sub>				13.7		
Fall Time	t <sub>f</sub>				19.1		

## DRAIN-SOURCE DIODE CHARACTERISTICS

Forward Diode Voltage	V <sub>SD</sub>	N	V <sub>GS</sub> = 0 V, T <sub>J</sub> = 25 °C	I <sub>S</sub> = 1.0 A	0.69	1.0	V
		P		I <sub>S</sub> = -1.0 A	-0.75	-1.0	
		N	V <sub>GS</sub> = 0 V, T <sub>J</sub> = 125 °C	I <sub>S</sub> = 1.0 A	0.52		
		P		I <sub>S</sub> = -1.0 A	-0.64		
Reverse Recovery Time	t <sub>RR</sub>	N	V <sub>GS</sub> = 0 V, dI <sub>S</sub> / dt = 100 A/μs	I <sub>S</sub> = 1.0 A	10.2		ns
		P		I <sub>S</sub> = -1.0 A	16.2		
Charge Time	t <sub>a</sub>	N		I <sub>S</sub> = 1.0 A	6.0		
		P		I <sub>S</sub> = -1.0 A	10.6		
Discharge Time	t <sub>b</sub>	N		I <sub>S</sub> = 1.0 A	4.2		
		P		I <sub>S</sub> = -1.0 A	5.6		
Reverse Recovery Charge	Q <sub>RR</sub>	N		I <sub>S</sub> = 1.0 A	3.0		nC
		P		I <sub>S</sub> = -1.0 A	5.7		

- Pulse Test: pulse width ≤ 300 μs, duty cycle ≤ 2%.
- Switching characteristics are independent of operating junction temperatures.

TYPICAL PERFORMANCE CURVES – N-CHANNEL ( $T_J = 25^\circ\text{C}$  unless otherwise noted)

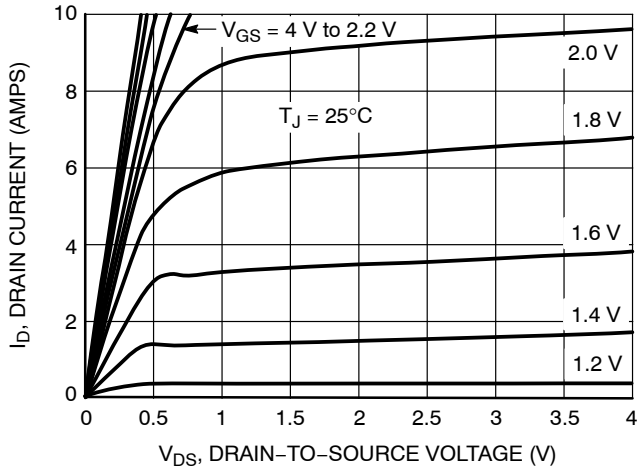

Figure 1. On-Region Characteristics

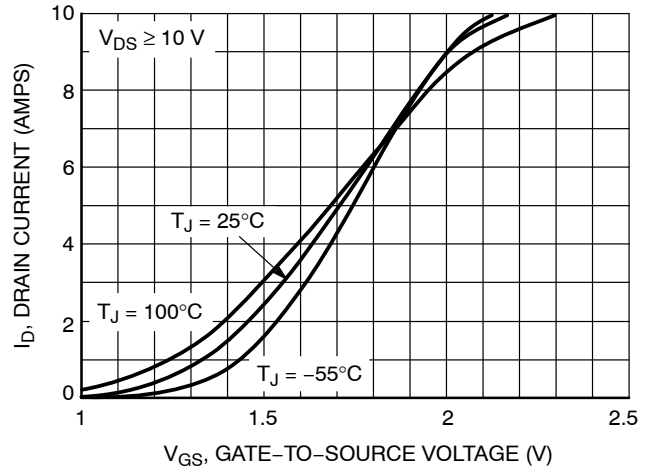

Figure 2. Transfer Characteristics

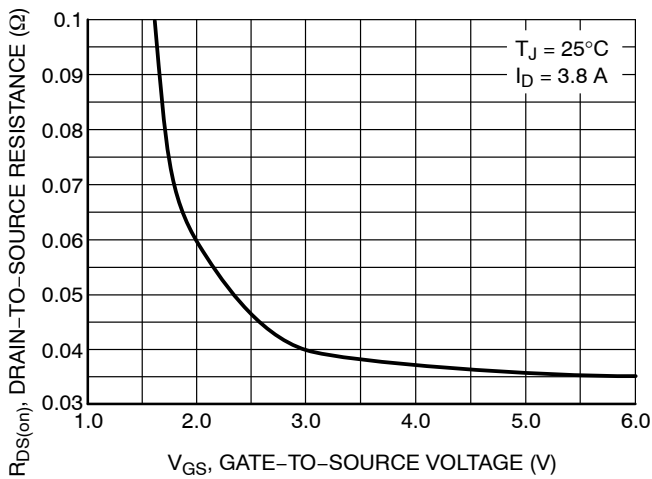

Figure 3. On-Resistance versus Drain Current

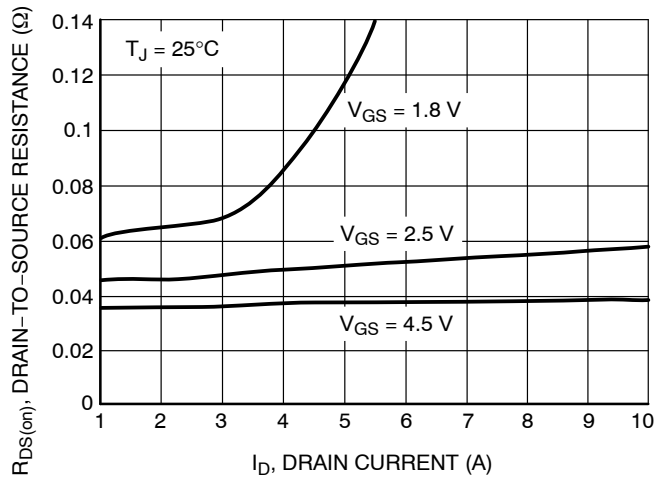

Figure 4. On-Resistance versus Drain Current and Gate Voltage

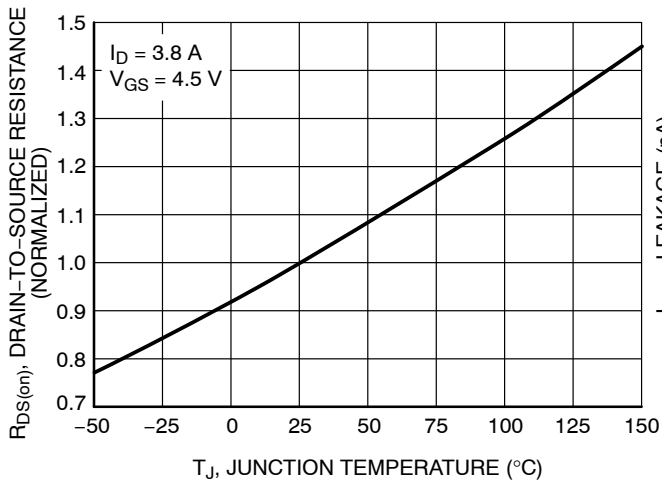

Figure 5. On-Resistance Variation with Temperature

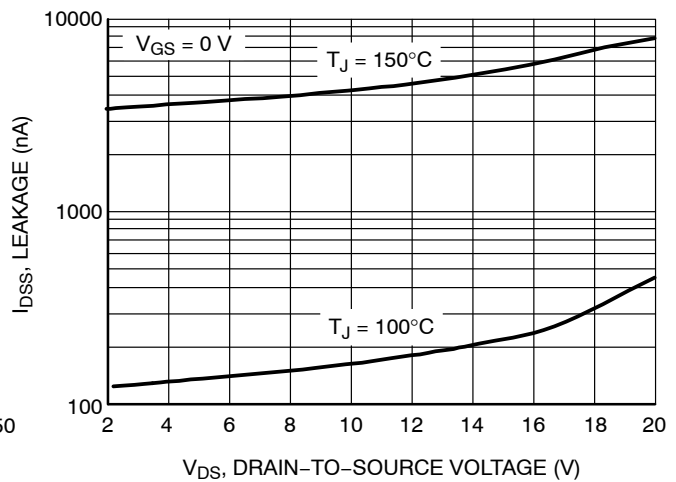

Figure 6. Drain-to-Source Leakage Current versus Voltage

TYPICAL PERFORMANCE CURVES – N-CHANNEL ( $T_J = 25^\circ\text{C}$  unless otherwise noted)

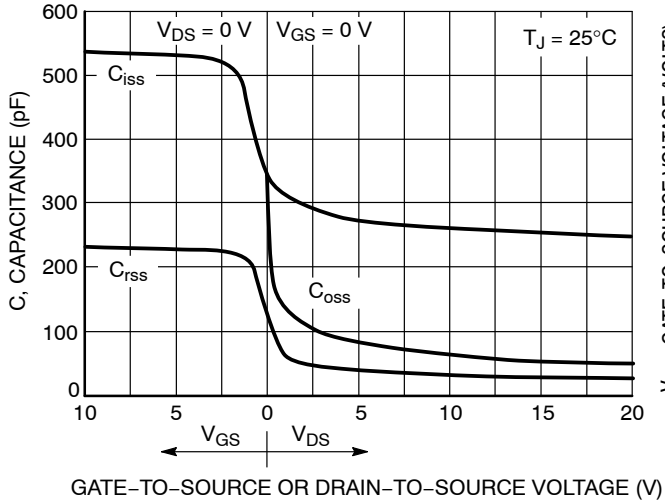

Figure 7. Capacitance Variation

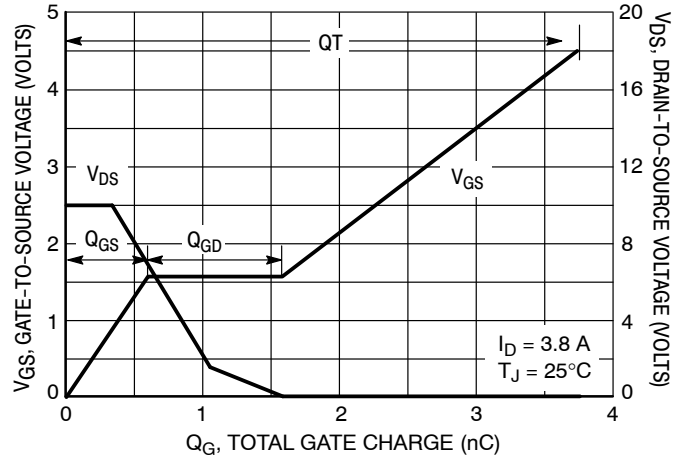

Figure 8. Gate-To-Source and Drain-To-Source Voltage versus Total Charge

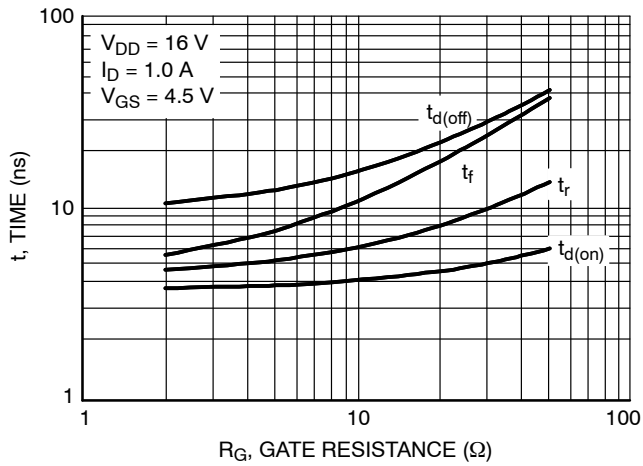

Figure 9. Resistive Switching Time Variation versus Gate Resistance

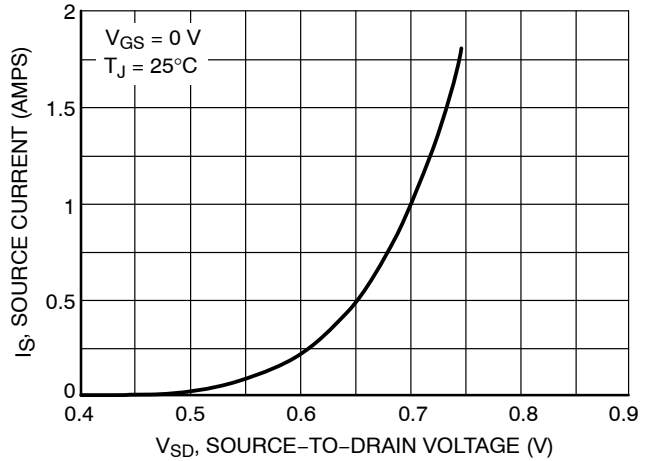
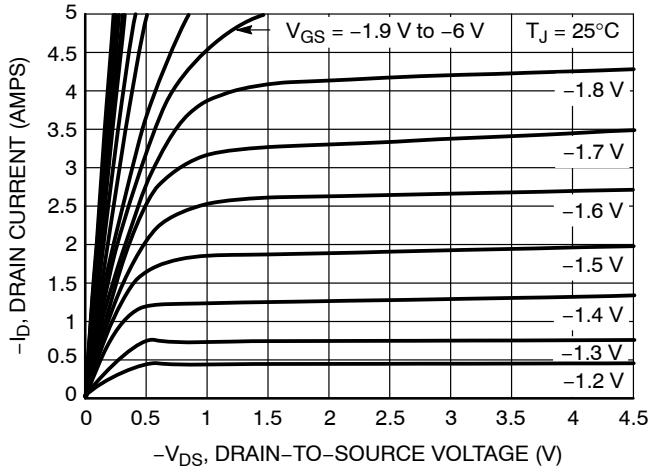

Figure 10. Diode Forward Voltage versus Current

# NTLJD3119C

## TYPICAL PERFORMANCE CURVES – P-CHANNEL ( $T_J = 25^\circ\text{C}$ unless otherwise noted)



**Figure 11. On-Region Characteristics**

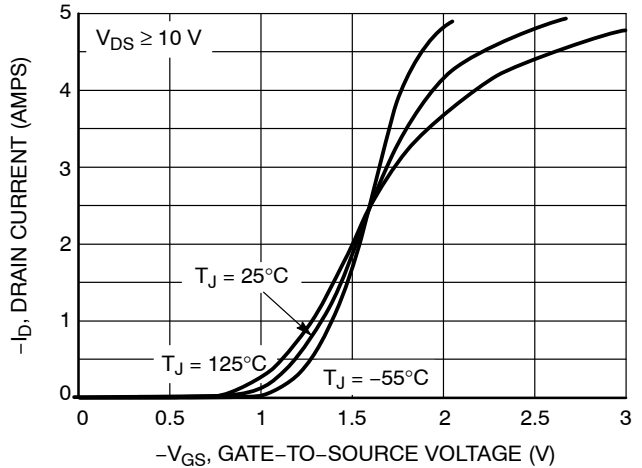

**Figure 12. Transfer Characteristics**

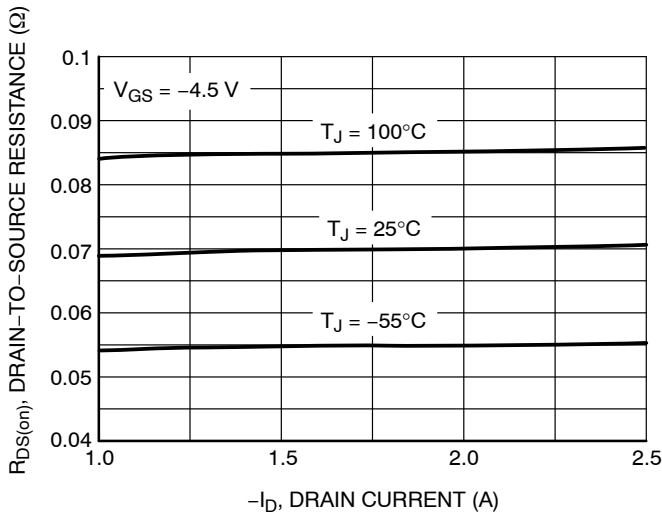

**Figure 13. On-Resistance versus Drain Current**

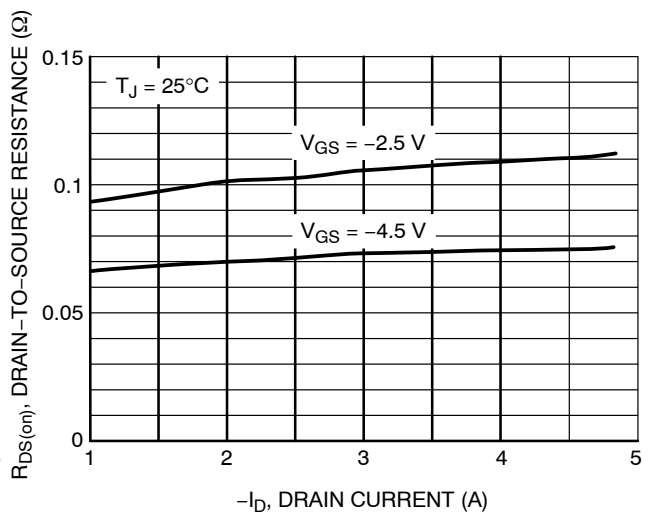

**Figure 14. On-Resistance versus Drain Current and Gate Voltage**

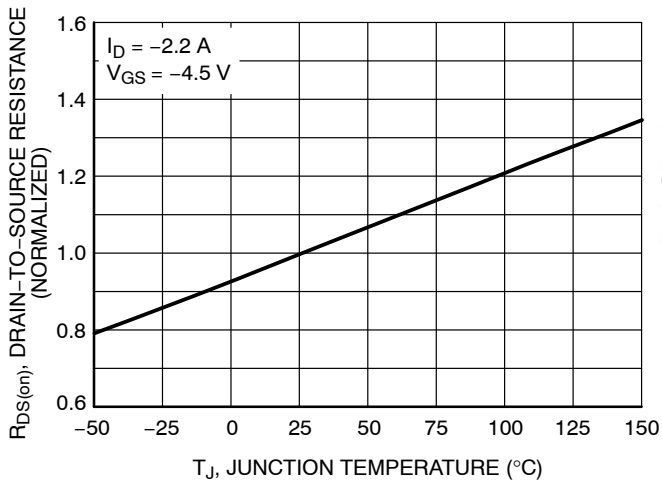

**Figure 15. On-Resistance Variation with Temperature**

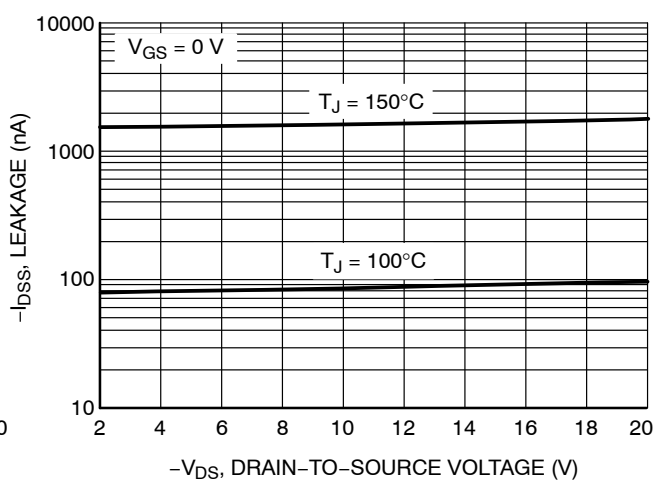

**Figure 16. Drain-to-Source Leakage Current versus Voltage**

TYPICAL PERFORMANCE CURVES – P-CHANNEL ( $T_J = 25^\circ\text{C}$  unless otherwise noted)

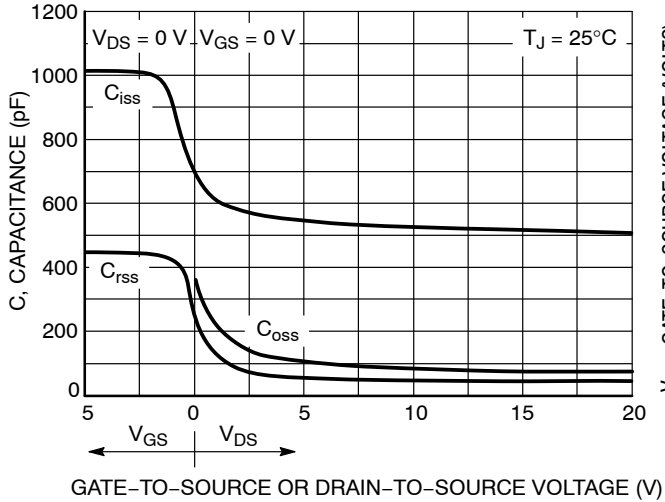

Figure 17. Capacitance Variation

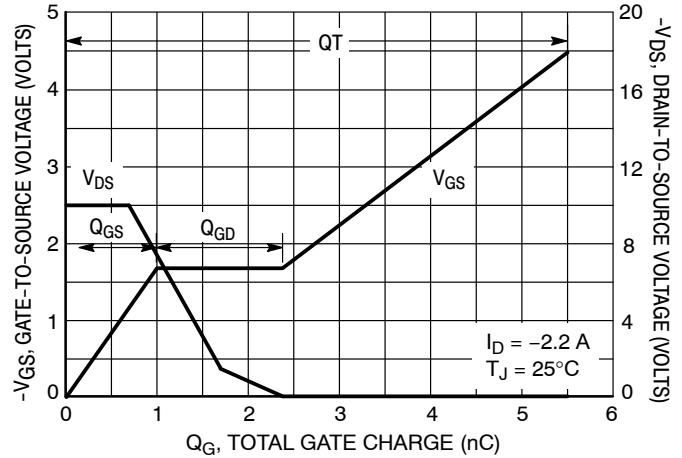

Figure 18. Gate-To-Source and Drain-To-Source Voltage versus Total Charge

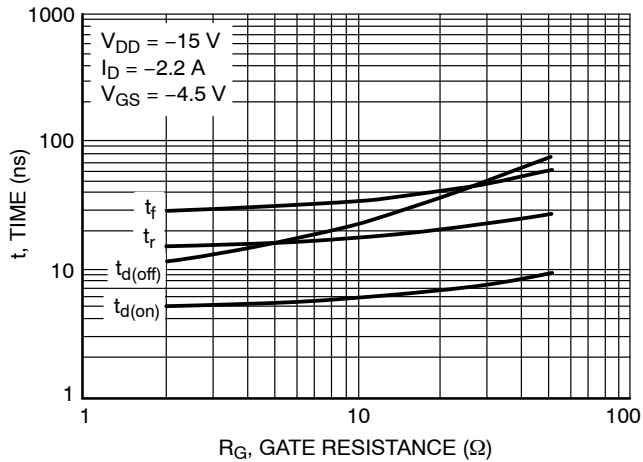

Figure 19. Resistive Switching Time Variation versus Gate Resistance

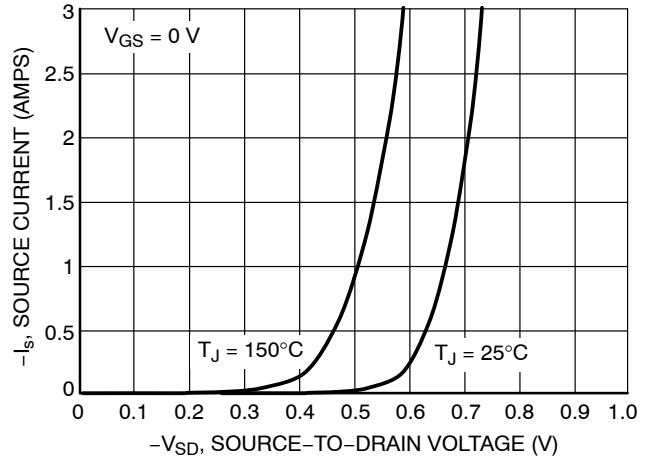

Figure 20. Diode Forward Voltage versus Current

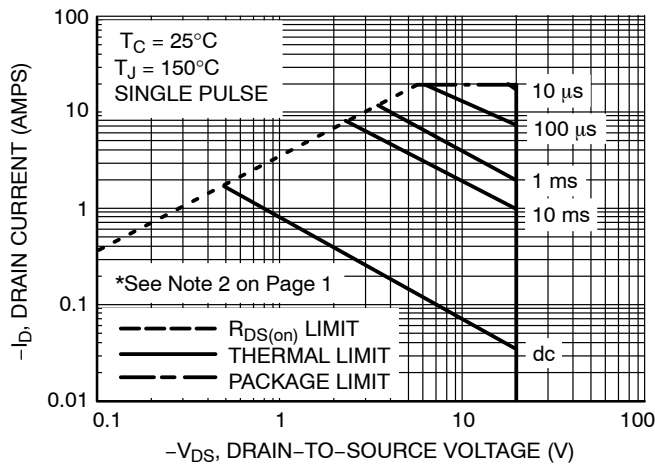

Figure 21. Maximum Rated Forward Biased Safe Operating Area



# NTLJD3119C

## TYPICAL PERFORMANCE CURVES ( $T_J = 25^\circ\text{C}$ unless otherwise noted)

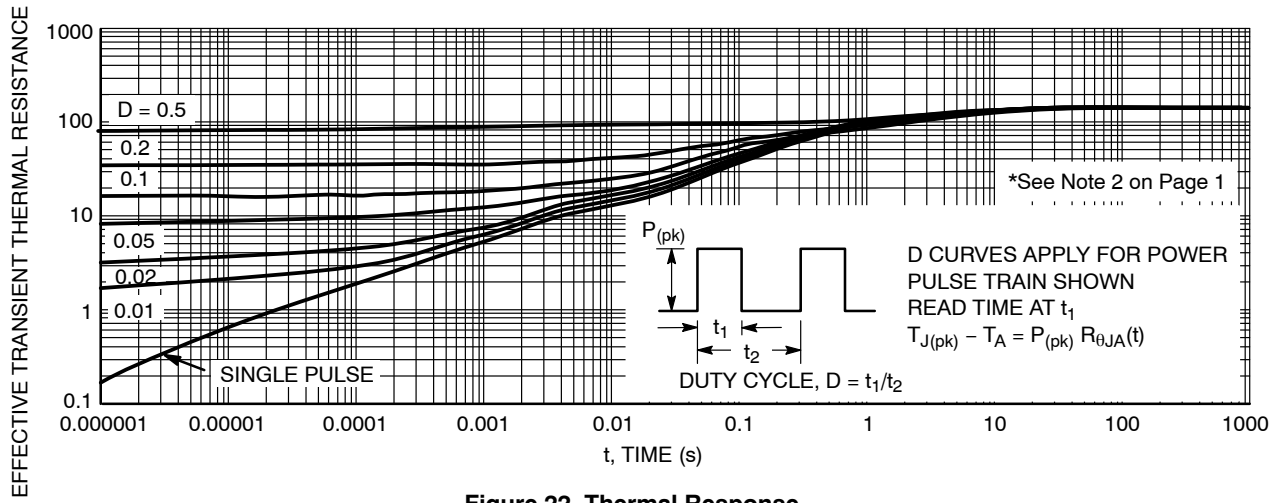
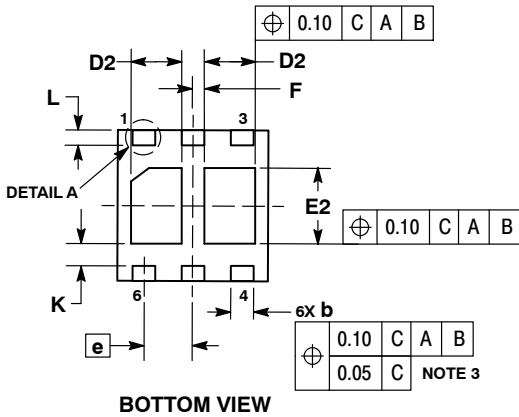
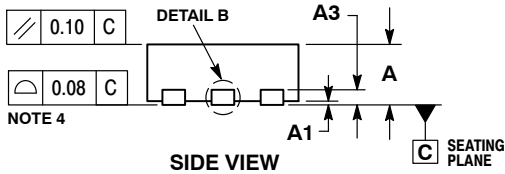
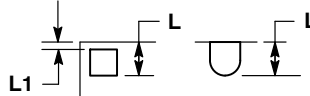
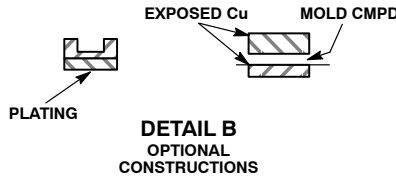
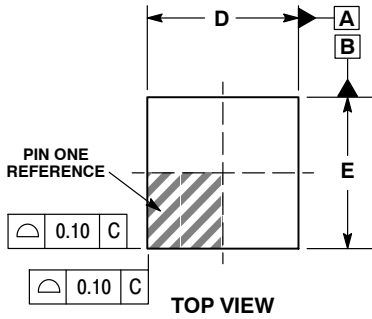

Figure 22. Thermal Response

# NTLJD3119C

## PACKAGE DIMENSIONS

WDFN6, 2x2, 0.65P  
CASE 506AN-01  
ISSUE D



### NOTES:

1. DIMENSIONING AND TOLERANCING PER ASME Y14.5M, 1994.
2. CONTROLLING DIMENSION: MILLIMETERS.
3. DIMENSION b APPLIES TO PLATED TERMINAL AND IS MEASURED BETWEEN 0.15 AND 0.30 mm FROM THE TERMINAL TIP.
4. COPLANARITY APPLIES TO THE EXPOSED PAD AS WELL AS THE TERMINALS.

DIM	MILLIMETERS	
	MIN	MAX
A	0.70	0.80
A1	0.00	0.05
A3	0.20 REF	
b	0.25	0.35
D	2.00 BSC	
D2	0.57	0.67
E	2.00 BSC	
E2	0.90	1.10
e	0.65 BSC	
F	0.15 BSC	
K	0.25 REF	
L	0.20	0.30
L1	---	0.10

### SOLDERMASK DEFINED MOUNTING FOOTPRINT

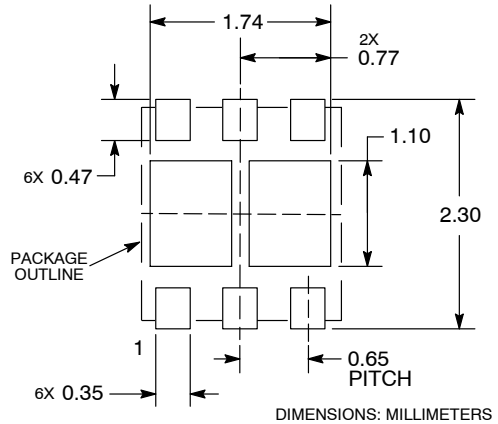

µCool is a trademark of Semiconductor Components Industries, LLC (SCILLC).

ON Semiconductor and  are registered trademarks of Semiconductor Components Industries, LLC (SCILLC). SCILLC reserves the right to make changes without further notice to any products herein. SCILLC makes no warranty, representation or guarantee regarding the suitability of its products for any particular purpose, nor does SCILLC assume any liability arising out of the application or use of any product or circuit, and specifically disclaims any and all liability, including without limitation special, consequential or incidental damages. "Typical" parameters which may be provided in SCILLC data sheets and/or specifications can and do vary in different applications and actual performance may vary over time. All operating parameters, including "Typicals" must be validated for each customer application by customer's technical experts. SCILLC does not convey any license under its patent rights nor the rights of others. SCILLC products are not designed, intended, or authorized for use as components in systems intended for surgical implant into the body, or other applications intended to support or sustain life, or for any other application in which the failure of the SCILLC product could create a situation where personal injury or death may occur. Should Buyer purchase or use SCILLC products for any such unintended or unauthorized application, Buyer shall indemnify and hold SCILLC and its officers, employees, subsidiaries, affiliates, and distributors harmless against all claims, costs, damages, and expenses, and reasonable attorney fees arising out of, directly or indirectly, any claim of personal injury or death associated with such unintended or unauthorized use, even if such claim alleges that SCILLC was negligent regarding the design or manufacture of the part. SCILLC is an Equal Opportunity/Affirmative Action Employer. This literature is subject to all applicable copyright laws and is not for resale in any manner.

### PUBLICATION ORDERING INFORMATION

**LITERATURE FULFILLMENT:**  
Literature Distribution Center for ON Semiconductor  
P.O. Box 5163, Denver, Colorado 80217 USA  
Phone: 303-675-2175 or 800-344-3860 Toll Free USA/Canada  
Fax: 303-675-2176 or 800-344-3867 Toll Free USA/Canada  
Email: [orderlit@onsemi.com](mailto:orderlit@onsemi.com)

**N. American Technical Support:** 800-282-9855 Toll Free  
USA/Canada  
**Europe, Middle East and Africa Technical Support:**  
Phone: 421 33 790 2910  
**Japan Customer Focus Center**  
Phone: 81-3-5773-3850

**ON Semiconductor Website:** [www.onsemi.com](http://www.onsemi.com)  
**Order Literature:** <http://www.onsemi.com/orderlit>

For additional information, please contact your local Sales Representative